



13 425 979



- Ausladung 22 mm
- PEARLSTREAM
- Platte 240 mm x 60 mm
- Anschluss 1/2" ablängbar
- Steckanschluss-Montage
- Durchfluss max. 9,5 l/min (bei 3 Bar)

Passt zu: IMO, LULU, MADISON, MEM, TARA, CL.1, LISSÉ, VAIA, META, CYO

	Chrom	13 425 979-00
	Platin gebürstet	13 425 979-06
	Platin	13 425 979-08
	Dark Chrome	13 425 979-19
	Light Gold	13 425 979-26
	Light Gold gebürstet	13 425 979-27
	Messing gebürstet (23kt Gold)	13 425 979-28
	Schwarz matt	13 425 979-33
	Bronze gebürstet	13 425 979-42
	Champagne gebürstet (22kt Gold)	13 425 979-46
	Champagne (22kt Gold)	13 425 979-47
	Chrom gebürstet	13 425 979-93
	Dark Platinum gebürstet	13 425 979-99

**Empfohlenes Zubehör**



**UP-Wandwinkel -**

- Max. Einbautiefe 163 mm
- Min. Einbautiefe 90 mm

35 085 970 90

**Empfohlenes Zubehör**



**UP-Wandwinkel -**

- Max. Einbautiefe 163 mm
- Min. Einbautiefe 90 mm

35 085 970 90

13 425 979

mm [inches]

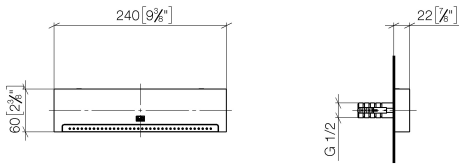

**Durchflussdiagramm**

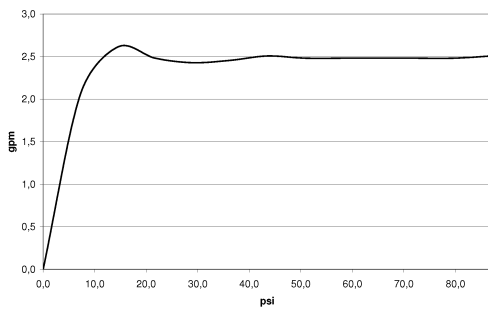

**Wurfweitendiagramm**

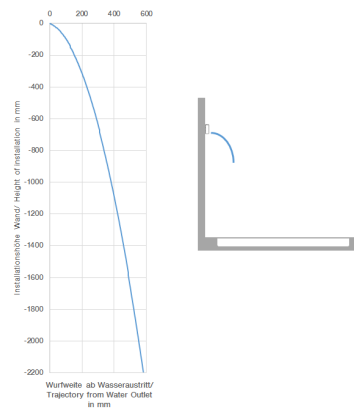

**Zertifikate**

LGA\_19935.

IAPMO\_4976 (6).

13 425 979

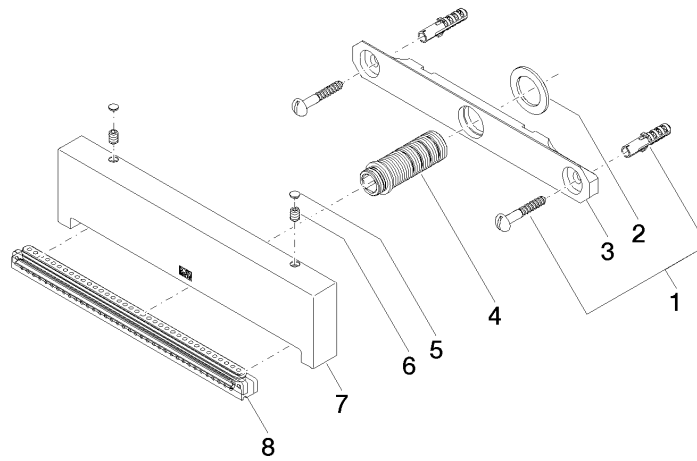

### Ersatzteilstückliste

Nr.	Artikelnummer	Benennung	Verbaumenge	Lieferzeit
1	04 30 31 024 01 90	Befestigungssatz	1	2
2	09 14 05 009 90	Dichtung	1	2
3	09 17 97 053 90	Halter	1	2
4	90 24 03 199 00 90	Anschluss	1	2
5	90 31 20 087 00-00	Stopfen	1	10
6	09 31 11 144 90	Stift	2	2
8	90 29 03 071 00 90	Einsatz	1	2